

## Metallized Polypropylene Capacitors (MKP/MFP)

Series/Type:      **B32632 ... B32634**

The following products presented in this data sheet are being withdrawn.

Ordering Code	Substitute Product	Date of Withdrawal	Deadline Last Orders	Last Shipments
B32632B7682M289		2015-07-24	2016-01-31	2016-07-31
B32632B7682M189		2015-07-24	2016-01-31	2016-07-31
B32632B7682M020		2015-07-24	2016-01-31	2016-07-31



Ordering Code	Substitute Product	Date of Withdrawal	Deadline Last Orders	Last Shipments
B32632B7682M010		2015-07-24	2016-01-31	2016-07-31
B32632B7682M008		2015-07-24	2016-01-31	2016-07-31
B32632B7682K289		2015-07-24	2016-01-31	2016-07-31
B32632B7682K189		2015-07-24	2016-01-31	2016-07-31
B32632B7682K020		2015-07-24	2016-01-31	2016-07-31
B32632B7682K010		2015-07-24	2016-01-31	2016-07-31
B32632B7682K008		2015-07-24	2016-01-31	2016-07-31
B32632B7682J289		2015-07-24	2016-01-31	2016-07-31
B32632B7682J189		2015-07-24	2016-01-31	2016-07-31
B32632B7682J020		2015-07-24	2016-01-31	2016-07-31
B32632B7682J010		2015-07-24	2016-01-31	2016-07-31
B32632B7682J008		2015-07-24	2016-01-31	2016-07-31
B32632B7472M289		2015-07-24	2016-01-31	2016-07-31
B32632B7472M189		2015-07-24	2016-01-31	2016-07-31
B32632B7472M020		2015-07-24	2016-01-31	2016-07-31
B32632B7472M010		2015-07-24	2016-01-31	2016-07-31
B32632B7472M008		2015-07-24	2016-01-31	2016-07-31
B32632B7472K289		2015-07-24	2016-01-31	2016-07-31
B32632B7472K189		2015-07-24	2016-01-31	2016-07-31
B32632B7472K020		2015-07-24	2016-01-31	2016-07-31
B32632B7472K010		2015-07-24	2016-01-31	2016-07-31
B32632B7472K008		2015-07-24	2016-01-31	2016-07-31
B32632B7472J289		2015-07-24	2016-01-31	2016-07-31
B32632B7472J189		2015-07-24	2016-01-31	2016-07-31
B32632B7472J020		2015-07-24	2016-01-31	2016-07-31
B32632B7472J010		2015-07-24	2016-01-31	2016-07-31
B32632B7472J008		2015-07-24	2016-01-31	2016-07-31
B32632B7332M289		2015-07-24	2016-01-31	2016-07-31
B32632B7332M189		2015-07-24	2016-01-31	2016-07-31
B32632B7332M020		2015-07-24	2016-01-31	2016-07-31
B32632B7332M010		2015-07-24	2016-01-31	2016-07-31
B32632B7332M008		2015-07-24	2016-01-31	2016-07-31
B32632B7332K289		2015-07-24	2016-01-31	2016-07-31
B32632B7332K189		2015-07-24	2016-01-31	2016-07-31
B32632B7332K020		2015-07-24	2016-01-31	2016-07-31
B32632B7332K010		2015-07-24	2016-01-31	2016-07-31
B32632B7332K008		2015-07-24	2016-01-31	2016-07-31
B32632B7332J289		2015-07-24	2016-01-31	2016-07-31



Ordering Code	Substitute Product	Date of Withdrawal	Deadline Last Orders	Last Shipments
B32632B7332J189		2015-07-24	2016-01-31	2016-07-31
B32632B7332J020		2015-07-24	2016-01-31	2016-07-31
B32632B7332J010		2015-07-24	2016-01-31	2016-07-31
B32632B7332J008		2015-07-24	2016-01-31	2016-07-31
B32632B7222M289		2015-07-24	2016-01-31	2016-07-31
B32632B7222M189		2015-07-24	2016-01-31	2016-07-31
B32632B7222M020		2015-07-24	2016-01-31	2016-07-31
B32632B7222M010		2015-07-24	2016-01-31	2016-07-31
B32632B7222M008		2015-07-24	2016-01-31	2016-07-31
B32632B7222K289		2015-07-24	2016-01-31	2016-07-31
B32632B7222K189		2015-07-24	2016-01-31	2016-07-31
B32632B7222K020		2015-07-24	2016-01-31	2016-07-31
B32632B7222K010		2015-07-24	2016-01-31	2016-07-31
B32632B7222K008		2015-07-24	2016-01-31	2016-07-31
B32632B7222J289		2015-07-24	2016-01-31	2016-07-31
B32632B7222J189		2015-07-24	2016-01-31	2016-07-31
B32632B7222J020		2015-07-24	2016-01-31	2016-07-31
B32632B7222J010		2015-07-24	2016-01-31	2016-07-31
B32632B7222J008		2015-07-24	2016-01-31	2016-07-31
B32632B7153M289		2015-07-24	2016-01-31	2016-07-31
B32632B7153M189		2015-07-24	2016-01-31	2016-07-31
B32632B7153M020		2015-07-24	2016-01-31	2016-07-31
B32632B7153M010		2015-07-24	2016-01-31	2016-07-31
B32632B7153M008		2015-07-24	2016-01-31	2016-07-31
B32632B7153K289		2015-07-24	2016-01-31	2016-07-31
B32632B7153K189		2015-07-24	2016-01-31	2016-07-31
B32632B7153K020		2015-07-24	2016-01-31	2016-07-31
B32632B7153K010		2015-07-24	2016-01-31	2016-07-31
B32632B7153K008		2015-07-24	2016-01-31	2016-07-31
B32632B7153J289		2015-07-24	2016-01-31	2016-07-31
B32632B7153J189		2015-07-24	2016-01-31	2016-07-31
B32632B7153J020		2015-07-24	2016-01-31	2016-07-31
B32632B7153J010		2015-07-24	2016-01-31	2016-07-31
B32632B7153J008		2015-07-24	2016-01-31	2016-07-31
B32632B7152M289		2015-07-24	2016-01-31	2016-07-31
B32632B7152M189		2015-07-24	2016-01-31	2016-07-31
B32632B7152M020		2015-07-24	2016-01-31	2016-07-31
B32632B7152M010		2015-07-24	2016-01-31	2016-07-31



Ordering Code	Substitute Product	Date of Withdrawal	Deadline Last Orders	Last Shipments
B32632B7152M008		2015-07-24	2016-01-31	2016-07-31
B32632B7152K289		2015-07-24	2016-01-31	2016-07-31
B32632B7152K189		2015-07-24	2016-01-31	2016-07-31
B32632B7152K020		2015-07-24	2016-01-31	2016-07-31
B32632B7152K010		2015-07-24	2016-01-31	2016-07-31
B32632B7152K008		2015-07-24	2016-01-31	2016-07-31
B32632B7152J289		2015-07-24	2016-01-31	2016-07-31
B32632B7152J189		2015-07-24	2016-01-31	2016-07-31
B32632B7152J020		2015-07-24	2016-01-31	2016-07-31
B32632B7152J010		2015-07-24	2016-01-31	2016-07-31
B32632B7152J008		2015-07-24	2016-01-31	2016-07-31
B32632B7103M289		2015-07-24	2016-01-31	2016-07-31
B32632B7103M189		2015-07-24	2016-01-31	2016-07-31
B32632B7103M020		2015-07-24	2016-01-31	2016-07-31
B32632B7103M010		2015-07-24	2016-01-31	2016-07-31
B32632B7103M008		2015-07-24	2016-01-31	2016-07-31
B32632B7103K289		2015-07-24	2016-01-31	2016-07-31
B32632B7103K189		2015-07-24	2016-01-31	2016-07-31
B32632B7103K020		2015-07-24	2016-01-31	2016-07-31
B32632B7103K010		2015-07-24	2016-01-31	2016-07-31
B32632B7103K008		2015-07-24	2016-01-31	2016-07-31
B32632B7103J289		2015-07-24	2016-01-31	2016-07-31
B32632B7103J189		2015-07-24	2016-01-31	2016-07-31
B32632B7103J020		2015-07-24	2016-01-31	2016-07-31
B32632B7103J010		2015-07-24	2016-01-31	2016-07-31
B32632B7103J008		2015-07-24	2016-01-31	2016-07-31
B32632B7102M289		2015-07-24	2016-01-31	2016-07-31
B32632B7102M189		2015-07-24	2016-01-31	2016-07-31
B32632B7102M020		2015-07-24	2016-01-31	2016-07-31
B32632B7102M010		2015-07-24	2016-01-31	2016-07-31
B32632B7102M008		2015-07-24	2016-01-31	2016-07-31
B32632B7102K289		2015-07-24	2016-01-31	2016-07-31
B32632B7102K189		2015-07-24	2016-01-31	2016-07-31
B32632B7102K020		2015-07-24	2016-01-31	2016-07-31
B32632B7102K010		2015-07-24	2016-01-31	2016-07-31
B32632B7102K008		2015-07-24	2016-01-31	2016-07-31
B32632B7102J289		2015-07-24	2016-01-31	2016-07-31
B32632B7102J189		2015-07-24	2016-01-31	2016-07-31



Ordering Code	Substitute Product	Date of Withdrawal	Deadline Last Orders	Last Shipments
B32632B7102J020		2015-07-24	2016-01-31	2016-07-31
B32632B7102J010		2015-07-24	2016-01-31	2016-07-31
B32632B7102J008		2015-07-24	2016-01-31	2016-07-31
B32632B6682M289		2015-07-24	2016-01-31	2016-07-31
B32632B6682M189		2015-07-24	2016-01-31	2016-07-31
B32632B6682M020		2015-07-24	2016-01-31	2016-07-31
B32632B6682M010		2015-07-24	2016-01-31	2016-07-31
B32632B6682M008		2015-07-24	2016-01-31	2016-07-31
B32632B6682K289		2015-07-24	2016-01-31	2016-07-31
B32632B6682K189		2015-07-24	2016-01-31	2016-07-31
B32632B6682K020		2015-07-24	2016-01-31	2016-07-31
B32632B6682K010		2015-07-24	2016-01-31	2016-07-31
B32632B6682K008		2015-07-24	2016-01-31	2016-07-31
B32632B6682J289		2015-07-24	2016-01-31	2016-07-31
B32632B6682J189		2015-07-24	2016-01-31	2016-07-31
B32632B6682J020		2015-07-24	2016-01-31	2016-07-31
B32632B6682J010		2015-07-24	2016-01-31	2016-07-31
B32632B6682J008		2015-07-24	2016-01-31	2016-07-31
B32632B6473M289		2015-07-24	2016-01-31	2016-07-31
B32632B6473M189		2015-07-24	2016-01-31	2016-07-31
B32632B6473M020		2015-07-24	2016-01-31	2016-07-31
B32632B6473M010		2015-07-24	2016-01-31	2016-07-31
B32632B6473M008		2015-07-24	2016-01-31	2016-07-31
B32632B6473K289		2015-07-24	2016-01-31	2016-07-31
B32632B6473K189		2015-07-24	2016-01-31	2016-07-31
B32632B6473K020		2015-07-24	2016-01-31	2016-07-31
B32632B6473K010		2015-07-24	2016-01-31	2016-07-31
B32632B6473K008		2015-07-24	2016-01-31	2016-07-31
B32632B6473J289		2015-07-24	2016-01-31	2016-07-31
B32632B6473J189		2015-07-24	2016-01-31	2016-07-31
B32632B6473J020		2015-07-24	2016-01-31	2016-07-31
B32632B6473J010		2015-07-24	2016-01-31	2016-07-31
B32632B6473J008		2015-07-24	2016-01-31	2016-07-31
B32632B6472M289		2015-07-24	2016-01-31	2016-07-31
B32632B6472M189		2015-07-24	2016-01-31	2016-07-31
B32632B6472M020		2015-07-24	2016-01-31	2016-07-31
B32632B6472M010		2015-07-24	2016-01-31	2016-07-31
B32632B6472M008		2015-07-24	2016-01-31	2016-07-31



Ordering Code	Substitute Product	Date of Withdrawal	Deadline Last Orders	Last Shipments
B32632B6472K289		2015-07-24	2016-01-31	2016-07-31
B32632B6472K189		2015-07-24	2016-01-31	2016-07-31
B32632B6472K020		2015-07-24	2016-01-31	2016-07-31
B32632B6472K010		2015-07-24	2016-01-31	2016-07-31
B32632B6472K008		2015-07-24	2016-01-31	2016-07-31
B32632B6472J289		2015-07-24	2016-01-31	2016-07-31
B32632B6472J189		2015-07-24	2016-01-31	2016-07-31
B32632B6472J020		2015-07-24	2016-01-31	2016-07-31
B32632B6472J010		2015-07-24	2016-01-31	2016-07-31
B32632B6472J008		2015-07-24	2016-01-31	2016-07-31
B32632B6333M289		2015-07-24	2016-01-31	2016-07-31
B32632B6333M189		2015-07-24	2016-01-31	2016-07-31
B32632B6333M020		2015-07-24	2016-01-31	2016-07-31
B32632B6333M010		2015-07-24	2016-01-31	2016-07-31
B32632B6333M008		2015-07-24	2016-01-31	2016-07-31
B32632B6333K289		2015-07-24	2016-01-31	2016-07-31
B32632B6333K189		2015-07-24	2016-01-31	2016-07-31
B32632B6333K020		2015-07-24	2016-01-31	2016-07-31
B32632B6333K010		2015-07-24	2016-01-31	2016-07-31
B32632B6333K008		2015-07-24	2016-01-31	2016-07-31
B32632B6333J289		2015-07-24	2016-01-31	2016-07-31
B32632B6333J189		2015-07-24	2016-01-31	2016-07-31
B32632B6333J020		2015-07-24	2016-01-31	2016-07-31
B32632B6333J010		2015-07-24	2016-01-31	2016-07-31
B32632B6333J008		2015-07-24	2016-01-31	2016-07-31
B32632B6332M289		2015-07-24	2016-01-31	2016-07-31
B32632B6332M189		2015-07-24	2016-01-31	2016-07-31
B32632B6332M020		2015-07-24	2016-01-31	2016-07-31
B32632B6332M010		2015-07-24	2016-01-31	2016-07-31
B32632B6332M008		2015-07-24	2016-01-31	2016-07-31
B32632B6332K289		2015-07-24	2016-01-31	2016-07-31
B32632B6332K189		2015-07-24	2016-01-31	2016-07-31
B32632B6332K020		2015-07-24	2016-01-31	2016-07-31
B32632B6332K010		2015-07-24	2016-01-31	2016-07-31
B32632B6332K008		2015-07-24	2016-01-31	2016-07-31
B32632B6332J289		2015-07-24	2016-01-31	2016-07-31
B32632B6332J189		2015-07-24	2016-01-31	2016-07-31
B32632B6332J020		2015-07-24	2016-01-31	2016-07-31



Ordering Code	Substitute Product	Date of Withdrawal	Deadline Last Orders	Last Shipments
B32632B6332J010		2015-07-24	2016-01-31	2016-07-31
B32632B6332J008		2015-07-24	2016-01-31	2016-07-31
B32632B6223M289		2015-07-24	2016-01-31	2016-07-31
B32632B6223M189		2015-07-24	2016-01-31	2016-07-31
B32632B6223M020		2015-07-24	2016-01-31	2016-07-31
B32632B6223M010		2015-07-24	2016-01-31	2016-07-31
B32632B6223M008		2015-07-24	2016-01-31	2016-07-31
B32632B6223K289		2015-07-24	2016-01-31	2016-07-31
B32632B6223K189		2015-07-24	2016-01-31	2016-07-31
B32632B6223K020		2015-07-24	2016-01-31	2016-07-31
B32632B6223K010		2015-07-24	2016-01-31	2016-07-31
B32632B6223K008		2015-07-24	2016-01-31	2016-07-31
B32632B6223J289		2015-07-24	2016-01-31	2016-07-31
B32632B6223J189		2015-07-24	2016-01-31	2016-07-31
B32632B6223J020		2015-07-24	2016-01-31	2016-07-31
B32632B6223J010		2015-07-24	2016-01-31	2016-07-31
B32632B6223J008		2015-07-24	2016-01-31	2016-07-31
B32632B6222M289		2015-07-24	2016-01-31	2016-07-31
B32632B6222M189		2015-07-24	2016-01-31	2016-07-31
B32632B6222M020		2015-07-24	2016-01-31	2016-07-31
B32632B6222M010		2015-07-24	2016-01-31	2016-07-31
B32632B6222M008		2015-07-24	2016-01-31	2016-07-31
B32632B6222K289		2015-07-24	2016-01-31	2016-07-31
B32632B6222K189		2015-07-24	2016-01-31	2016-07-31
B32632B6222K020		2015-07-24	2016-01-31	2016-07-31
B32632B6222K010		2015-07-24	2016-01-31	2016-07-31
B32632B6222K008		2015-07-24	2016-01-31	2016-07-31
B32632B6222J289		2015-07-24	2016-01-31	2016-07-31
B32632B6222J189		2015-07-24	2016-01-31	2016-07-31
B32632B6222J020		2015-07-24	2016-01-31	2016-07-31
B32632B6222J010		2015-07-24	2016-01-31	2016-07-31
B32632B6222J008		2015-07-24	2016-01-31	2016-07-31
B32632B6153M289		2015-07-24	2016-01-31	2016-07-31
B32632B6153M189		2015-07-24	2016-01-31	2016-07-31
B32632B6153M020		2015-07-24	2016-01-31	2016-07-31
B32632B6153M010		2015-07-24	2016-01-31	2016-07-31
B32632B6153M008		2015-07-24	2016-01-31	2016-07-31
B32632B6153K289		2015-07-24	2016-01-31	2016-07-31



Ordering Code	Substitute Product	Date of Withdrawal	Deadline Last Orders	Last Shipments
B32632B6153K189		2015-07-24	2016-01-31	2016-07-31
B32632B6153K020		2015-07-24	2016-01-31	2016-07-31
B32632B6153K010		2015-07-24	2016-01-31	2016-07-31
B32632B6153K008		2015-07-24	2016-01-31	2016-07-31
B32632B6153J289		2015-07-24	2016-01-31	2016-07-31
B32632B6153J189		2015-07-24	2016-01-31	2016-07-31
B32632B6153J020		2015-07-24	2016-01-31	2016-07-31
B32632B6153J010		2015-07-24	2016-01-31	2016-07-31
B32632B6153J008		2015-07-24	2016-01-31	2016-07-31
B32632B6103M289		2015-07-24	2016-01-31	2016-07-31
B32632B6103M189		2015-07-24	2016-01-31	2016-07-31
B32632B6103M020		2015-07-24	2016-01-31	2016-07-31
B32632B6103M010		2015-07-24	2016-01-31	2016-07-31
B32632B6103M008		2015-07-24	2016-01-31	2016-07-31
B32632B6103K289		2015-07-24	2016-01-31	2016-07-31
B32632B6103K189		2015-07-24	2016-01-31	2016-07-31
B32632B6103K020		2015-07-24	2016-01-31	2016-07-31
B32632B6103K010		2015-07-24	2016-01-31	2016-07-31
B32632B6103K008		2015-07-24	2016-01-31	2016-07-31
B32632B6103J289		2015-07-24	2016-01-31	2016-07-31
B32632B6103J189		2015-07-24	2016-01-31	2016-07-31
B32632B6103J020		2015-07-24	2016-01-31	2016-07-31
B32632B6103J010		2015-07-24	2016-01-31	2016-07-31
B32632B6103J008		2015-07-24	2016-01-31	2016-07-31
B32632B4681K289		2015-07-24	2016-01-31	2016-07-31
B32632B4681K189		2015-07-24	2016-01-31	2016-07-31
B32632B4681K020		2015-07-24	2016-01-31	2016-07-31
B32632B4681K010		2015-07-24	2016-01-31	2016-07-31
B32632B4681K008		2015-07-24	2016-01-31	2016-07-31
B32632B4471K289		2015-07-24	2016-01-31	2016-07-31
B32632B4471K189		2015-07-24	2016-01-31	2016-07-31
B32632B4471K020		2015-07-24	2016-01-31	2016-07-31
B32632B4471K010		2015-07-24	2016-01-31	2016-07-31
B32632B4471K008		2015-07-24	2016-01-31	2016-07-31
B32632B4222M289		2015-07-24	2016-01-31	2016-07-31
B32632B4222M189		2015-07-24	2016-01-31	2016-07-31
B32632B4222M020		2015-07-24	2016-01-31	2016-07-31
B32632B4222M010		2015-07-24	2016-01-31	2016-07-31





Ordering Code	Substitute Product	Date of Withdrawal	Deadline Last Orders	Last Shipments
B32632B4222M008		2015-07-24	2016-01-31	2016-07-31
B32632B4222K289		2015-07-24	2016-01-31	2016-07-31
B32632B4222K189		2015-07-24	2016-01-31	2016-07-31
B32632B4222K020		2015-07-24	2016-01-31	2016-07-31
B32632B4222K010		2015-07-24	2016-01-31	2016-07-31
B32632B4222K008		2015-07-24	2016-01-31	2016-07-31
B32632B4222J289		2015-07-24	2016-01-31	2016-07-31
B32632B4222J189		2015-07-24	2016-01-31	2016-07-31
B32632B4222J020		2015-07-24	2016-01-31	2016-07-31
B32632B4222J010		2015-07-24	2016-01-31	2016-07-31
B32632B4222J008		2015-07-24	2016-01-31	2016-07-31
B32632B4152M289		2015-07-24	2016-01-31	2016-07-31
B32632B4152M189		2015-07-24	2016-01-31	2016-07-31
B32632B4152M020		2015-07-24	2016-01-31	2016-07-31
B32632B4152M010		2015-07-24	2016-01-31	2016-07-31
B32632B4152M008		2015-07-24	2016-01-31	2016-07-31
B32632B4152K289		2015-07-24	2016-01-31	2016-07-31
B32632B4152K189		2015-07-24	2016-01-31	2016-07-31
B32632B4152K020		2015-07-24	2016-01-31	2016-07-31
B32632B4152K010		2015-07-24	2016-01-31	2016-07-31
B32632B4152K008		2015-07-24	2016-01-31	2016-07-31
B32632B4152J289		2015-07-24	2016-01-31	2016-07-31
B32632B4152J189		2015-07-24	2016-01-31	2016-07-31
B32632B4152J020		2015-07-24	2016-01-31	2016-07-31
B32632B4152J010		2015-07-24	2016-01-31	2016-07-31
B32632B4152J008		2015-07-24	2016-01-31	2016-07-31
B32632B4102M289		2015-07-24	2016-01-31	2016-07-31
B32632B4102M189		2015-07-24	2016-01-31	2016-07-31
B32632B4102M020		2015-07-24	2016-01-31	2016-07-31
B32632B4102M010		2015-07-24	2016-01-31	2016-07-31
B32632B4102M008		2015-07-24	2016-01-31	2016-07-31
B32632B4102K289		2015-07-24	2016-01-31	2016-07-31
B32632B4102K189		2015-07-24	2016-01-31	2016-07-31
B32632B4102K020		2015-07-24	2016-01-31	2016-07-31
B32632B4102K010		2015-07-24	2016-01-31	2016-07-31
B32632B4102K008		2015-07-24	2016-01-31	2016-07-31
B32632B4102J289		2015-07-24	2016-01-31	2016-07-31
B32632B4102J189		2015-07-24	2016-01-31	2016-07-31



Ordering Code	Substitute Product	Date of Withdrawal	Deadline Last Orders	Last Shipments
B32632B4102J020		2015-07-24	2016-01-31	2016-07-31
B32632B4102J010		2015-07-24	2016-01-31	2016-07-31
B32632B4102J008		2015-07-24	2016-01-31	2016-07-31
B32632B2682M289		2015-07-24	2016-01-31	2016-07-31
B32632B2682M189		2015-07-24	2016-01-31	2016-07-31
B32632B2682M020		2015-07-24	2016-01-31	2016-07-31
B32632B2682M010		2015-07-24	2016-01-31	2016-07-31
B32632B2682M008		2015-07-24	2016-01-31	2016-07-31
B32632B2682K289		2015-07-24	2016-01-31	2016-07-31
B32632B2682K189		2015-07-24	2016-01-31	2016-07-31
B32632B2682K020		2015-07-24	2016-01-31	2016-07-31
B32632B2682K010		2015-07-24	2016-01-31	2016-07-31
B32632B2682K008		2015-07-24	2016-01-31	2016-07-31
B32632B2682J289		2015-07-24	2016-01-31	2016-07-31
B32632B2682J189		2015-07-24	2016-01-31	2016-07-31
B32632B2682J020		2015-07-24	2016-01-31	2016-07-31
B32632B2682J010		2015-07-24	2016-01-31	2016-07-31
B32632B2682J008		2015-07-24	2016-01-31	2016-07-31
B32632B2681M289		2015-07-24	2016-01-31	2016-07-31
B32632B2681M189		2015-07-24	2016-01-31	2016-07-31
B32632B2681M020		2015-07-24	2016-01-31	2016-07-31
B32632B2681M010		2015-07-24	2016-01-31	2016-07-31
B32632B2681M008		2015-07-24	2016-01-31	2016-07-31
B32632B2472M289		2015-07-24	2016-01-31	2016-07-31
B32632B2472M189		2015-07-24	2016-01-31	2016-07-31
B32632B2472M020		2015-07-24	2016-01-31	2016-07-31
B32632B2472M010		2015-07-24	2016-01-31	2016-07-31
B32632B2472M008		2015-07-24	2016-01-31	2016-07-31
B32632B2472K289		2015-07-24	2016-01-31	2016-07-31
B32632B2472K189		2015-07-24	2016-01-31	2016-07-31
B32632B2472K020		2015-07-24	2016-01-31	2016-07-31
B32632B2472K010		2015-07-24	2016-01-31	2016-07-31
B32632B2472K008		2015-07-24	2016-01-31	2016-07-31
B32632B2472J289		2015-07-24	2016-01-31	2016-07-31
B32632B2472J189		2015-07-24	2016-01-31	2016-07-31
B32632B2472J020		2015-07-24	2016-01-31	2016-07-31
B32632B2472J010		2015-07-24	2016-01-31	2016-07-31
B32632B2472J008		2015-07-24	2016-01-31	2016-07-31



Ordering Code	Substitute Product	Date of Withdrawal	Deadline Last Orders	Last Shipments
B32632B2471M289		2015-07-24	2016-01-31	2016-07-31
B32632B2471M189		2015-07-24	2016-01-31	2016-07-31
B32632B2471M020		2015-07-24	2016-01-31	2016-07-31
B32632B2471M010		2015-07-24	2016-01-31	2016-07-31
B32632B2471M008		2015-07-24	2016-01-31	2016-07-31
B32632B2332M289		2015-07-24	2016-01-31	2016-07-31
B32632B2332M189		2015-07-24	2016-01-31	2016-07-31
B32632B2332M020		2015-07-24	2016-01-31	2016-07-31
B32632B2332M010		2015-07-24	2016-01-31	2016-07-31
B32632B2332M008		2015-07-24	2016-01-31	2016-07-31
B32632B2332K289		2015-07-24	2016-01-31	2016-07-31
B32632B2332K189		2015-07-24	2016-01-31	2016-07-31
B32632B2332K020		2015-07-24	2016-01-31	2016-07-31
B32632B2332K010		2015-07-24	2016-01-31	2016-07-31
B32632B2332K008		2015-07-24	2016-01-31	2016-07-31
B32632B2332J289		2015-07-24	2016-01-31	2016-07-31
B32632B2332J189		2015-07-24	2016-01-31	2016-07-31
B32632B2332J020		2015-07-24	2016-01-31	2016-07-31
B32632B2332J010		2015-07-24	2016-01-31	2016-07-31
B32632B2332J008		2015-07-24	2016-01-31	2016-07-31
B32632B2222M289		2015-07-24	2016-01-31	2016-07-31
B32632B2222M189		2015-07-24	2016-01-31	2016-07-31
B32632B2222M020		2015-07-24	2016-01-31	2016-07-31
B32632B2222M010		2015-07-24	2016-01-31	2016-07-31
B32632B2222M008		2015-07-24	2016-01-31	2016-07-31
B32632B2222K289		2015-07-24	2016-01-31	2016-07-31
B32632B2222K189		2015-07-24	2016-01-31	2016-07-31
B32632B2222K020		2015-07-24	2016-01-31	2016-07-31
B32632B2222K010		2015-07-24	2016-01-31	2016-07-31
B32632B2222K008		2015-07-24	2016-01-31	2016-07-31
B32632B2222J289		2015-07-24	2016-01-31	2016-07-31
B32632B2222J189		2015-07-24	2016-01-31	2016-07-31
B32632B2222J020		2015-07-24	2016-01-31	2016-07-31
B32632B2222J010		2015-07-24	2016-01-31	2016-07-31
B32632B2222J008		2015-07-24	2016-01-31	2016-07-31
B32632B2152M289		2015-07-24	2016-01-31	2016-07-31
B32632B2152M189		2015-07-24	2016-01-31	2016-07-31
B32632B2152M020		2015-07-24	2016-01-31	2016-07-31



Ordering Code	Substitute Product	Date of Withdrawal	Deadline Last Orders	Last Shipments
B32632B2152M010		2015-07-24	2016-01-31	2016-07-31
B32632B2152M008		2015-07-24	2016-01-31	2016-07-31
B32632B2152K289		2015-07-24	2016-01-31	2016-07-31
B32632B2152K189		2015-07-24	2016-01-31	2016-07-31
B32632B2152K020		2015-07-24	2016-01-31	2016-07-31
B32632B2152K010		2015-07-24	2016-01-31	2016-07-31
B32632B2152K008		2015-07-24	2016-01-31	2016-07-31
B32632B2152J289		2015-07-24	2016-01-31	2016-07-31
B32632B2152J189		2015-07-24	2016-01-31	2016-07-31
B32632B2152J020		2015-07-24	2016-01-31	2016-07-31
B32632B2152J010		2015-07-24	2016-01-31	2016-07-31
B32632B2152J008		2015-07-24	2016-01-31	2016-07-31
B32632B2102M289		2015-07-24	2016-01-31	2016-07-31
B32632B2102M189		2015-07-24	2016-01-31	2016-07-31
B32632B2102M020		2015-07-24	2016-01-31	2016-07-31
B32632B2102M010		2015-07-24	2016-01-31	2016-07-31
B32632B2102M008		2015-07-24	2016-01-31	2016-07-31
B32632B2102K289		2015-07-24	2016-01-31	2016-07-31
B32632B2102K189		2015-07-24	2016-01-31	2016-07-31
B32632B2102K020		2015-07-24	2016-01-31	2016-07-31
B32632B2102K010		2015-07-24	2016-01-31	2016-07-31
B32632B2102K008		2015-07-24	2016-01-31	2016-07-31
B32632B2102J289		2015-07-24	2016-01-31	2016-07-31
B32632B2102J189		2015-07-24	2016-01-31	2016-07-31
B32632B2102J020		2015-07-24	2016-01-31	2016-07-31
B32632B2102J010		2015-07-24	2016-01-31	2016-07-31
B32632B2102J008		2015-07-24	2016-01-31	2016-07-31
B32632B1682M289		2015-07-24	2016-01-31	2016-07-31
B32632B1682M189		2015-07-24	2016-01-31	2016-07-31
B32632B1682M020		2015-07-24	2016-01-31	2016-07-31
B32632B1682M010		2015-07-24	2016-01-31	2016-07-31
B32632B1682M008		2015-07-24	2016-01-31	2016-07-31
B32632B1682K289		2015-07-24	2016-01-31	2016-07-31
B32632B1682K189		2015-07-24	2016-01-31	2016-07-31
B32632B1682K020		2015-07-24	2016-01-31	2016-07-31
B32632B1682K010		2015-07-24	2016-01-31	2016-07-31
B32632B1682K008		2015-07-24	2016-01-31	2016-07-31
B32632B1682J289		2015-07-24	2016-01-31	2016-07-31



Ordering Code	Substitute Product	Date of Withdrawal	Deadline Last Orders	Last Shipments
B32632B1682J189		2015-07-24	2016-01-31	2016-07-31
B32632B1682J020		2015-07-24	2016-01-31	2016-07-31
B32632B1682J010		2015-07-24	2016-01-31	2016-07-31
B32632B1682J008		2015-07-24	2016-01-31	2016-07-31
B32632B1472M289		2015-07-24	2016-01-31	2016-07-31
B32632B1472M189		2015-07-24	2016-01-31	2016-07-31
B32632B1472M020		2015-07-24	2016-01-31	2016-07-31
B32632B1472M010		2015-07-24	2016-01-31	2016-07-31
B32632B1472M008		2015-07-24	2016-01-31	2016-07-31
B32632B1472K289		2015-07-24	2016-01-31	2016-07-31
B32632B1472K189		2015-07-24	2016-01-31	2016-07-31
B32632B1472K020		2015-07-24	2016-01-31	2016-07-31
B32632B1472K010		2015-07-24	2016-01-31	2016-07-31
B32632B1472K008		2015-07-24	2016-01-31	2016-07-31
B32632B1472J289		2015-07-24	2016-01-31	2016-07-31
B32632B1472J189		2015-07-24	2016-01-31	2016-07-31
B32632B1472J020		2015-07-24	2016-01-31	2016-07-31
B32632B1472J010		2015-07-24	2016-01-31	2016-07-31
B32632B1472J008		2015-07-24	2016-01-31	2016-07-31
B32632B1332M289		2015-07-24	2016-01-31	2016-07-31
B32632B1332M189		2015-07-24	2016-01-31	2016-07-31
B32632B1332M020		2015-07-24	2016-01-31	2016-07-31
B32632B1332M010		2015-07-24	2016-01-31	2016-07-31
B32632B1332M008		2015-07-24	2016-01-31	2016-07-31
B32632B1332K289		2015-07-24	2016-01-31	2016-07-31
B32632B1332K189		2015-07-24	2016-01-31	2016-07-31
B32632B1332K020		2015-07-24	2016-01-31	2016-07-31
B32632B1332K010		2015-07-24	2016-01-31	2016-07-31
B32632B1332K008		2015-07-24	2016-01-31	2016-07-31
B32632B1332J289		2015-07-24	2016-01-31	2016-07-31
B32632B1332J189		2015-07-24	2016-01-31	2016-07-31
B32632B1332J020		2015-07-24	2016-01-31	2016-07-31
B32632B1332J010		2015-07-24	2016-01-31	2016-07-31
B32632B1332J008		2015-07-24	2016-01-31	2016-07-31
B32632B1222M289		2015-07-24	2016-01-31	2016-07-31
B32632B1222M189		2015-07-24	2016-01-31	2016-07-31
B32632B1222M020		2015-07-24	2016-01-31	2016-07-31
B32632B1222M010		2015-07-24	2016-01-31	2016-07-31



Ordering Code	Substitute Product	Date of Withdrawal	Deadline Last Orders	Last Shipments
B32632B1222M008		2015-07-24	2016-01-31	2016-07-31
B32632B1222K289		2015-07-24	2016-01-31	2016-07-31
B32632B1222K189		2015-07-24	2016-01-31	2016-07-31
B32632B1222K020		2015-07-24	2016-01-31	2016-07-31
B32632B1222K010		2015-07-24	2016-01-31	2016-07-31
B32632B1222K008		2015-07-24	2016-01-31	2016-07-31
B32632B1222J289		2015-07-24	2016-01-31	2016-07-31
B32632B1222J189		2015-07-24	2016-01-31	2016-07-31
B32632B1222J020		2015-07-24	2016-01-31	2016-07-31
B32632B1222J010		2015-07-24	2016-01-31	2016-07-31
B32632B1222J008		2015-07-24	2016-01-31	2016-07-31
B32632B1152M289		2015-07-24	2016-01-31	2016-07-31
B32632B1152M189		2015-07-24	2016-01-31	2016-07-31
B32632B1152M020		2015-07-24	2016-01-31	2016-07-31
B32632B1152M010		2015-07-24	2016-01-31	2016-07-31
B32632B1152M008		2015-07-24	2016-01-31	2016-07-31
B32632B1152K289		2015-07-24	2016-01-31	2016-07-31
B32632B1152K189		2015-07-24	2016-01-31	2016-07-31
B32632B1152K020		2015-07-24	2016-01-31	2016-07-31
B32632B1152K010		2015-07-24	2016-01-31	2016-07-31
B32632B1152K008		2015-07-24	2016-01-31	2016-07-31
B32632B1152J289		2015-07-24	2016-01-31	2016-07-31
B32632B1152J189		2015-07-24	2016-01-31	2016-07-31
B32632B1152J020		2015-07-24	2016-01-31	2016-07-31
B32632B1152J010		2015-07-24	2016-01-31	2016-07-31
B32632B1152J008		2015-07-24	2016-01-31	2016-07-31
B32632B1103M289		2015-07-24	2016-01-31	2016-07-31
B32632B1103M189		2015-07-24	2016-01-31	2016-07-31
B32632B1103M020		2015-07-24	2016-01-31	2016-07-31
B32632B1103M010		2015-07-24	2016-01-31	2016-07-31
B32632B1103M008		2015-07-24	2016-01-31	2016-07-31
B32632B1103K289		2015-07-24	2016-01-31	2016-07-31
B32632B1103K189		2015-07-24	2016-01-31	2016-07-31
B32632B1103K020		2015-07-24	2016-01-31	2016-07-31
B32632B1103K010		2015-07-24	2016-01-31	2016-07-31
B32632B1103K008		2015-07-24	2016-01-31	2016-07-31
B32632B1103J289		2015-07-24	2016-01-31	2016-07-31
B32632B1103J189		2015-07-24	2016-01-31	2016-07-31



Ordering Code	Substitute Product	Date of Withdrawal	Deadline Last Orders	Last Shipments
B32632B1103J020		2015-07-24	2016-01-31	2016-07-31
B32632B1103J010		2015-07-24	2016-01-31	2016-07-31
B32632B1103J008		2015-07-24	2016-01-31	2016-07-31
B32632B1102M289		2015-07-24	2016-01-31	2016-07-31
B32632B1102M189		2015-07-24	2016-01-31	2016-07-31
B32632B1102M020		2015-07-24	2016-01-31	2016-07-31
B32632B1102M010		2015-07-24	2016-01-31	2016-07-31
B32632B1102M008		2015-07-24	2016-01-31	2016-07-31
B32632B1102K289		2015-07-24	2016-01-31	2016-07-31
B32632B1102K189		2015-07-24	2016-01-31	2016-07-31
B32632B1102K020		2015-07-24	2016-01-31	2016-07-31
B32632B1102K010		2015-07-24	2016-01-31	2016-07-31
B32632B1102K008		2015-07-24	2016-01-31	2016-07-31
B32632B1102J289		2015-07-24	2016-01-31	2016-07-31
B32632B1102J189		2015-07-24	2016-01-31	2016-07-31
B32632B1102J020		2015-07-24	2016-01-31	2016-07-31
B32632B1102J010		2015-07-24	2016-01-31	2016-07-31
B32632B1102J008		2015-07-24	2016-01-31	2016-07-31

For further information please contact your nearest EPCOS sales office, which will also support you in selecting a suitable substitute. The addresses of our worldwide sales network are presented at [www.epcos.com/sales](http://www.epcos.com/sales).

**Very high pulse (wound)****Typical applications**

- Smoothing
- High-frequency AC loads
- Switch-mode power supplies
- Electronic ballasts
- HID lamps

**Climatic**

- Max. operating temperature: 110 °C
- Climatic category (IEC 60068-1): 55/100/56

**Construction**

- Dielectric: polypropylene (PP)
- Film metallized on one side and metal foils internally connected in series
- Contact layer of sprayed metal
- Wound capacitor technology
- Epoxy resin coating (UL 94 V-0)

**Features**

- Highest possible contact reliability
- Very high pulse strength
- Self-healing properties
- RoHS-compatible

**Terminals**

- Crimped wire leads, lead-free tinned, lead length (6 – 1 mm)
- Double crimped wire leads, lead-free tinned
- Straight wire leads, lead-free tinned, lead length (17 ±3 mm)
- Different lead spacings (reduced and enlarged) available, lead length (6 – 1 mm)

**Marking**

Manufacturer's logo, style and type (P63x), rated capacitance (coded), capacitance tolerance (code letter), rated DC voltage, date of manufacture (coded)

**Delivery mode**

Bulk (untaped)

Taped (Ammo pack or reel)

For notes on taping, refer to chapter "Taping and packing".

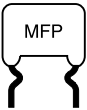
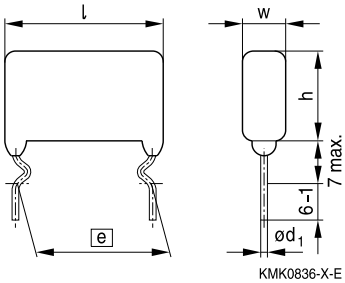
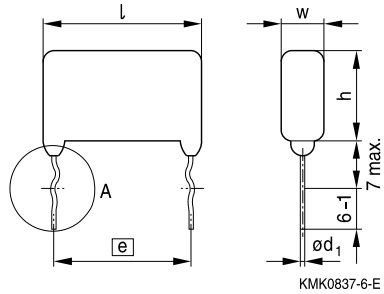
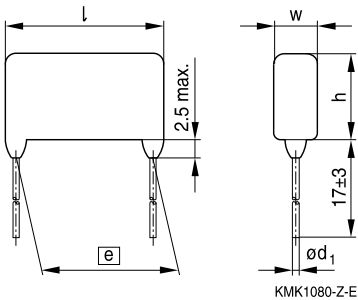
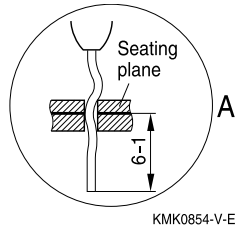

**Dimensional drawings**
**Crimped leads**

**Double crimped leads**

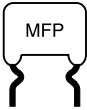
**Straight leads**

**Detail of double crimped version**

**Dimensions in mm**

Lead spacing	Lead diameter	Type
$\boxed{e} \pm 0.8$	$d_1$	
15.0	0.8	B32632
22.5	0.8	B32633
27.5	0.8	B32634



**B32632 ... B32634**

**Very high pulse (wound)**

**Overview of available types**

Lead spacing	15.0 mm					22.5 mm					
Type	B32632					B32633					
V <sub>R</sub> (V DC)	630	1250	1600	2000	3000	630	1250	1600	2000	2500	3000
V <sub>RMS</sub> (V AC)	300	450	450	500	750	300	450	450	500	750	750
C <sub>R</sub> (nF)											
0.47											
0.68											
1.0											
1.5											
2.2											
3.3											
4.7											
6.8											
10											
15											
22											
33											
47											
68											
100											

**Lead configurations**

Series	Standard	Reduced	Straight	Double crimped
B32632	15 mm	7.5 / 10 / 12.5 mm	15 mm	15 mm
B32633	22.5 mm	15 / 17.5 / 20 mm	22.5 mm	22.5 mm
B32634	27.5 mm	25 mm	27.5 mm	27.5 mm

**Overview of available types**

Lead spacing	27.5 mm			
Type	B32634			
$V_R$ (V DC)	630	1250	1600	2000
$V_{RMS}$ (V AC)	300	450	450	500
$C_R$ (nF)				
10				
15				
22				
33				
47				
68				
100				
150				
220				
330				

**Lead configurations**

Series	Standard	Reduced	Straight	Double crimped
B32632	15 mm	7.5 / 10 / 12.5 mm	15 mm	15 mm
B32633	22.5 mm	15 / 17.5 / 20 mm	22.5 mm	22.5 mm
B32634	27.5 mm	25 mm	27.5 mm	27.5 mm

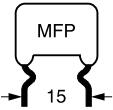
**B32632**
**Very high pulse (wound)**
**Ordering codes and packing units (lead spacing 15 mm)**

$V_R$	$V_{RMS}$ $f \leq 1$ kHz	$C_R$	Max. dimensions $w \times h \times l$ mm	Ordering code (composition see below)	Ammo pack pcs./MOQ	Reel pcs./MOQ	Untaped pcs./MOQ
V DC	V AC	nF					
630	300	2.2	6.0 × 11.5 × 18.5	B32632B6222+***	3600	4800	4000
		3.3	6.0 × 11.5 × 18.5	B32632B6332+***	3600	4800	4000
		4.7	6.0 × 11.5 × 18.5	B32632B6472+***	3600	4800	4000
		6.8	6.0 × 11.5 × 18.5	B32632B6682+***	3600	4800	4000
		10	6.0 × 11.5 × 18.5	B32632B6103+***	3600	4800	4000
		15	6.5 × 12.0 × 18.5	B32632B6153+***	3200	4000	4000
		22	7.5 × 13.5 × 18.5	B32632B6223+***	2800	3600	4000
		33	9.0 × 15.0 × 18.5	B32632B6333+***	2400	3200	2000
		47	11.0 × 16.5 × 18.5	B32632B6473+***	1800	2400	2000
1250	450	1.0	6.0 × 11.5 × 18.5	B32632B7102+***	3400	4400	4000
		1.5	6.0 × 11.5 × 18.5	B32632B7152+***	3400	4400	4000
		2.2	6.5 × 12.0 × 18.5	B32632B7222+***	3400	4400	4000
		3.3	6.5 × 12.0 × 18.5	B32632B7332+***	3200	4000	4000
		4.7	7.0 × 12.5 × 18.5	B32632B7472+***	3200	4000	4000
		6.8	7.5 × 14.0 × 18.5	B32632B7682+***	3000	4000	4000
		10	9.0 × 15.0 × 18.5	B32632B7103+***	2400	3200	2000
		15	11.5 × 16.5 × 18.5	B32632B7153+***	1800	2400	2000

MOQ = Minimum Order Quantity, consisting of 4 packing units.

B32632B2471M\*\*\* and B32632B2681M\*\*\* are only available in M tolerance.

B32632B4471K\*\*\* and B32632B4681K\*\*\* are only available in K tolerance.

Further E series and intermediate capacitance values on request.

**Composition of ordering code**

+ = Capacitance tolerance code:

M = ±20%

K = ±10%

J = ±5%

\*\*\* = Packaging code:

289 = Ammo pack

189 = Reel

010 = Untaped crimped (lead length 6 – 1 mm)

008 = Untaped straight (lead length 17±3 mm)

020 = Double crimped (lead length 6 – 1 mm)

Packaging codes for further lead configurations (untaped):

Lead configuration (lead length 6 – 1 mm)	Reduced	Reduced	Reduced	Enlarged
Lead spacing (mm)	7.5 mm	10 mm	12.5 mm	17.5 mm
Packaging code	030	040	050	060

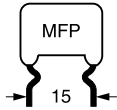
**Ordering codes and packing units (lead spacing 15 mm)**

$V_R$	$V_{RMS}$ $f \leq 1$ kHz	$C_R$	Max. dimensions $w \times h \times l$ mm	Ordering code (composition see below)	Ammo pack pcs./MOQ	Reel pcs./MOQ	Untaped pcs./MOQ
V DC	V AC	nF					
1600	450	1.0	6.0 × 11.5 × 18.5	B32632B1102+***	3600	4800	4000
		1.5	6.0 × 11.5 × 18.5	B32632B1152+***	3600	4800	4000
		2.2	6.5 × 12.0 × 18.5	B32632B1222+***	3200	4000	4000
		3.3	7.5 × 13.0 × 18.5	B32632B1332+***	2800	3600	4000
		4.7	8.5 × 14.0 × 18.5	B32632B1472+***	2400	3200	4000
		6.8	9.5 × 15.0 × 18.5	B32632B1682+***	2000	2800	2000
		10	11.5 × 17.0 × 18.5	B32632B1103+***	1800	2400	2000
2000	500	0.47	6.5 × 11.5 × 18.5	B32632B2471M***	3400	4400	4000
		0.68	6.5 × 12.0 × 18.5	B32632B2681M***	3400	4400	4000
		1.0	6.5 × 12.0 × 18.5	B32632B2102+***	3400	4400	4000
		1.5	6.5 × 12.0 × 18.5	B32632B2152+***	3400	4400	4000
		2.2	7.0 × 13.0 × 18.5	B32632B2222+***	2400	4000	2000
		3.3	8.5 × 14.5 × 18.5	B32632B2332+***	2600	3400	2000
		4.7	10.0 × 16.0 × 18.5	B32632B2472+***	2000	2800	2000
		6.8	12.0 × 17.5 × 18.5	B32632B2682+***	1800	2400	2000
3000	750	0.47	6.5 × 11.5 × 18.5	B32632B4471K***	4000	5200	4000
		0.68	7.0 × 13.0 × 18.5	B32632B4681K***	3600	4800	4000
		1.0	8.5 × 14.0 × 18.5	B32632B4102+***	3000	4000	2000
		1.5	9.5 × 16.5 × 18.5	B32632B4152+***	2600	3400	2000
		2.2	12.0 × 17.5 × 18.5	B32632B4222+***	2000	2800	2000

MOQ = Minimum Order Quantity, consisting of 4 packing units.

B32632B2471M\*\*\* and B32632B2681M\*\*\* are only available in M tolerance.

B32632B4471K\*\*\* and B32632B4681K\*\*\* are only available in K tolerance.

Further E series and intermediate capacitance values on request.

**Composition of ordering code**

+ = Capacitance tolerance code:

M = ±20%

K = ±10%

J = ±5%

\*\*\* = Packaging code:

289 = Ammo pack

189 = Reel

010 = Untaped crimped (lead length 6 – 1 mm)

008 = Untaped straight (lead length 17±3 mm)

020 = Double crimped (lead length 6 – 1 mm)

Packaging codes for further lead configurations (untaped):

Lead configuration (lead length 6 – 1 mm)	Reduced	Reduced	Reduced	Enlarged
Lead spacing (mm)	7.5 mm	10 mm	12.5 mm	17.5 mm
Packaging code	030	040	050	060

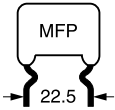
**B32633**
**Very high pulse (wound)**
**Ordering codes and packing units (lead spacing 22.5 mm)**

$V_R$	$V_{RMS}$ $f \leq 1$ kHz	$C_R$	Max. dimensions $w \times h \times l$ mm	Ordering code (composition see below)	Ammo pack pcs./MOQ	Reel pcs./MOQ	Untaped pcs./MOQ
V DC	V AC	nF					
630	300	22	$6.5 \times 12.0 \times 27.0$	B32633B6223+***	2200	3000	4000
		33	$7.0 \times 14.0 \times 27.0$	B32633B6333+***	2000	2800	2000
		47	$7.5 \times 14.5 \times 27.0$	B32633B6473+***	1800	2400	2000
		68	$9.0 \times 16.0 \times 27.0$	B32633B6683+***	1400	2000	2000
		100	$10.5 \times 18.5 \times 27.0$	B32633B6104+***	1200	1600	1000
1250	450	10	$7.0 \times 14.0 \times 27.0$	B32633B7103+***	2000	2800	2000
		15	$8.0 \times 15.5 \times 27.0$	B32633B7153+***	1800	2400	2000
		22	$9.5 \times 16.5 \times 27.0$	B32633B7223+***	1400	2000	2000
		33	$11.5 \times 19.0 \times 27.0$	B32633B7333+***	1200	1600	1000
		47	$13.5 \times 20.5 \times 27.0$	B32633B7473+***	1000	1400	1000
1600	450	3.3	$6.5 \times 12.5 \times 27.0$	B32633B1332+***	2000	2800	4000
		4.7	$6.5 \times 12.5 \times 27.0$	B32633B1472+***	2000	2800	4000
		6.8	$7.0 \times 14.5 \times 27.0$	B32633B1682+***	2000	2400	2000
		10	$8.0 \times 15.5 \times 27.0$	B32633B1103+***	1800	2600	2000
		15	$9.5 \times 17.0 \times 27.0$	B32633B1153+***	1400	2000	1000
		22	$11.5 \times 19.0 \times 27.0$	B32633B1223+***	1200	1600	1000
		33	$14.5 \times 22.0 \times 27.0$	B32633B1333+***	1000	1200	1000
2000	500	2.2	$6.5 \times 13.0 \times 27.0$	B32633B2222+***	2000	2800	4000
		3.3	$6.5 \times 13.0 \times 27.0$	B32633B2332+***	2000	2800	4000
		4.7	$7.0 \times 14.5 \times 27.0$	B32633B2472+***	2000	2800	2000
		6.8	$8.5 \times 16.0 \times 27.0$	B32633B2682+***	1600	2200	2000
		10	$10.0 \times 17.0 \times 27.0$	B32633B2103+***	1400	1800	1000
		15	$12.0 \times 19.5 \times 27.0$	B32633B2153+***	1000	1400	1000
		22	$14.5 \times 22.0 \times 27.0$	B32633B2223+***	800	1200	1000

MOQ = Minimum Order Quantity, consisting of 4 packing units.

Further E series and intermediate capacitance values on request.

**Composition of ordering code**

+= Capacitance tolerance code:

 K =  $\pm 10\%$ 

 J =  $\pm 5\%$ 

\*\*\* = Packaging code:

289 = Ammo pack

189 = Reel

010 = Untaped crimped (lead length 6 – 1 mm)

 008 = Untaped straight (lead length 17 $\pm$ 3 mm)

020 = Double crimped (lead length 6 – 1 mm)

Packaging codes for further lead configurations (untaped):

Lead configuration (lead length 6 – 1 mm)	Reduced	Reduced	Reduced	Enlarged
Lead spacing (mm)	15 mm	17.5 mm	20 mm	25 mm
Packaging code	055	060	070	080

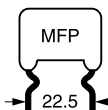
**Ordering codes and packing units (lead spacing 22.5 mm)**

$V_R$	$V_{RMS}$ $f \leq 1$ kHz	$C_R$	Max. dimensions $w \times h \times l$ mm	Ordering code (composition see below)	Ammo pack pcs./MOQ	Reel pcs./MOQ	Untaped pcs./MOQ
V DC	V AC	nF					
2500	750	1.0	7.0 × 13.5 × 27.0	B32633B3102+***	1800	2600	4000
		1.5	7.0 × 14.0 × 27.0	B32633B3152+***	1800	2600	4000
		2.2	7.5 × 15.0 × 27.0	B32633B3222+***	1800	2400	2000
		3.3	9.0 × 16.0 × 27.0	B32633B3332+***	1400	2000	2000
		4.7	10.0 × 18.0 × 27.0	B32633B3472+***	1400	2000	2000
		6.8	12.0 × 20.5 × 27.0	B32633B3682+***	1200	1600	1000
		10	14.0 × 23.0 × 27.0	B32633B3103+***	1000	1400	1000
		15	17.0 × 26.0 × 27.0	B32633B3153+***	800	1200	800
3000	750	1.0	6.5 × 12.0 × 27.0	B32633B4102+***	2600	3600	2000
		1.5	7.5 × 13.5 × 27.0	B32633B4152+***	2200	3000	2000
		2.2	8.5 × 15.0 × 27.0	B32633B4222+***	1800	2600	2000
		3.3	10.0 × 17.0 × 27.0	B32633B4332+***	1600	2200	2000
		4.7	11.5 × 19.0 × 27.0	B32633B4472+***	1200	1800	2000
		6.8	13.0 × 22.0 × 27.0	B32633B4682+***	1000	1400	800

MOQ = Minimum Order Quantity, consisting of 4 packing units.

Further E series and intermediate capacitance values on request.

**Composition of ordering code**

+ = Capacitance tolerance code:

K = ±10%

J = ±5%

\*\*\* = Packaging code:

289 = Ammo pack

189 = Reel

010 = Untaped crimped (lead length 6 – 1 mm)

008 = Untaped straight (lead length 17±3 mm)

020 = Double crimped (lead length 6 – 1 mm)

Packaging codes for further lead configurations (untaped):

Lead configuration (lead length 6 – 1 mm)	Reduced	Reduced	Reduced	Enlarged
Lead spacing (mm)	15 mm	17.5 mm	20 mm	25 mm
Packaging code	055	060	070	080

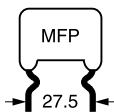
**B32634**
**Very high pulse (wound)**
**Ordering codes and packing units (lead spacing 27.5 mm)**

$V_R$	$V_{RMS}$ $f \leq 1 \text{ kHz}$	$C_R$	Max. dimensions $w \times h \times l$	Ordering code (composition see below)	Untaped pcs./MOQ
V DC	V AC	nF	mm		
630	300	100	9.5 × 18.0 × 32.0	B32634B6104+***	1000
		150	11.5 × 20.5 × 32.0	B32634B6154+***	800
		220	13.5 × 22.5 × 32.0	B32634B6224+***	800
		330	16.0 × 25.5 × 32.0	B32634B6334+***	600
1250	450	33	9.5 × 18.0 × 32.0	B32634B7333+***	1000
		47	11.5 × 20.0 × 32.0	B32634B7473+***	1000
		68	13.0 × 23.0 × 32.0	B32634B7683+***	800
		100	16.0 × 26.0 × 32.0	B32634B7104+***	600
1600	450	15	8.5 × 17.0 × 32.0	B32634B1153+***	2000
		22	10.0 × 18.5 × 32.0	B32634B1223+***	1000
		33	12.0 × 21.5 × 32.0	B32634B1333+***	1000
		47	14.0 × 22.5 × 32.0	B32634B1473+***	800
		68	16.0 × 25.5 × 32.0	B32634B1683+***	600
2000	500	10	8.5 × 17.0 × 32.0	B32634A2103+***	2000
		15	10.0 × 19.5 × 32.0	B32634A2153+***	1000
		22	12.0 × 21.5 × 32.0	B32634A2223+***	1000
		33	15.0 × 24.0 × 32.0	B32634A2333+***	800

MOQ = Minimum Order Quantity, consisting of 4 packing units.

Further E series and intermediate capacitance values on request.

**Composition of ordering code**

+ = Capacitance tolerance code:

K = ±10%

J = ±5%

\*\*\* = Packaging code:

010 = Untaped crimped (lead length 6 – 1 mm)

008 = Untaped straight (lead length 17±3 mm)

020 = Double crimped (lead length 6 – 1 mm)

Packaging codes for further lead configurations (untaped):

Lead configuration (lead length 6 – 1 mm)	Reduced
Lead spacing (mm)	25 mm
Packaging code	090

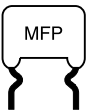

**Technical data**

Operating temperature range	Max. operating temperature $T_{op,max}$	+110 °C	
	Upper category temperature $T_{max}$	+100 °C	
	Lower category temperature $T_{min}$	-55 °C	
	Rated temperature $T_R$	+85 °C	
Dissipation factor $\tan \delta$ at 20 °C (upper limit values)	1.0 · 10 <sup>-3</sup> (at 10 kHz)		
	2.0 · 10 <sup>-3</sup> (at 100 kHz)		
Insulation resistance $R_{ins}$ at 20 °C, rel. humidity ≤ 65% (minimum as-delivered values)	100 GΩ		
DC test voltage	2.0 · $V_R$ , 2 s (B32632/3000 V DC: 1.2 · $V_R$ , 2 s; B32633/3000 V DC: 1.6 · $V_R$ , 2 s)		
Category voltage $V_C$ (continuous operation with $V_{DC}$ or $V_{AC}$ at $f \leq 1$ kHz)	$T_A$ (°C)	DC voltage derating	AC voltage derating
	$T_A \leq 85$ $85 < T_A \leq 100$	$V_C = V_R$ $V_C = V_R \cdot (165 - T_A)/80$	$V_{C,RMS} = V_{RMS}$ $V_{C,RMS} = V_{RMS} \cdot (165 - T_A)/80$
Operating voltage $V_{op}$ for short operating periods ( $V_{DC}$ or $V_{AC}$ at $f \leq 1$ kHz)	$T_A$ (°C)	DC voltage (max. hours)	AC voltage (max. hours)
	$T_A \leq 85$ $85 < T_A \leq 100$	$V_{op} = 1.25 \cdot V_C$ (2000 h) $V_{op} = 1.25 \cdot V_C$ (1000 h)	$V_{op} = 1.0 \cdot V_{C,RMS}$ (2000 h) $V_{op} = 1.0 \cdot V_{C,RMS}$ (1000 h)
Damp heat test Limit values after damp heat test	56 days/40 °C/93% relative humidity Capacitance change $ \Delta C/C $ ≤ 2% Dissipation factor change $\Delta \tan \delta$ ≤ 1.0 · 10 <sup>-3</sup> (at 10 kHz) Insulation resistance $R_{ins}$ ≥ 50% of minimum as-delivered values		
Reliability: Failure rate $\lambda$ Service life $t_{SL}$	1 fit (≤ 2 · 10 <sup>-9</sup> /h) at 0.5 · $V_R$ , 40 °C 200 000 h at 1.0 · $V_R$ , 85 °C For conversion to other operating conditions and temperatures, refer to chapter "Quality, 2 Reliability".		
Failure criteria: Total failure Failure due to variation of parameters	Short circuit or open circuit Capacitance change $ \Delta C/C $ > 10% Dissipation factor $\tan \delta$ > 4 · upper limit value Insulation resistance $R_{ins}$ < 1500 MΩ		

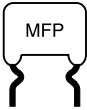

B32632 ... B32634

Very high pulse (wound)

### Pulse handling capability

"dV/dt" represents the maximum permissible voltage change per unit of time for non-sinusoidal voltages, expressed in V/μs.

"k<sub>0</sub>" represents the maximum permissible pulse characteristic of the waveform applied to the capacitor, expressed in V<sup>2</sup>/μs.

Note:

The values of dV/dt and k<sub>0</sub> provided below must not be exceeded in order to avoid damaging the capacitor.

#### dV/dt values

Lead spacing		15 mm	22.5 mm	27.5 mm
V <sub>R</sub> V DC	V <sub>RMS</sub> V AC	dV/dt in V/μs		
630	300	6 000	3 600	2 400
1250	450	14 400	8 400	5 400
1600	450	16 800	10 800	6 600
2000	500	20 400	14 400	8 400
2500	750	–	16 800	–
3000	750	21 600	18 000	–

#### k<sub>0</sub> values

Lead spacing		15 mm	22.5 mm	27.5 mm
V <sub>R</sub> V DC	V <sub>RMS</sub> V AC	k <sub>0</sub> in V <sup>2</sup> /μs		
630	300	7 560 000	4 536 000	3 024 000
1250	450	36 000 000	21 000 000	13 500 000
1600	450	53 760 000	34 560 000	21 120 000
2000	500	81 600 000	57 600 000	33 600 000
2500	750	–	84 000 000	–
3000	750	129 600 000	108 000 000	–

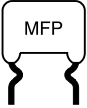

**Impedance Z versus frequency f**  
(typical values)

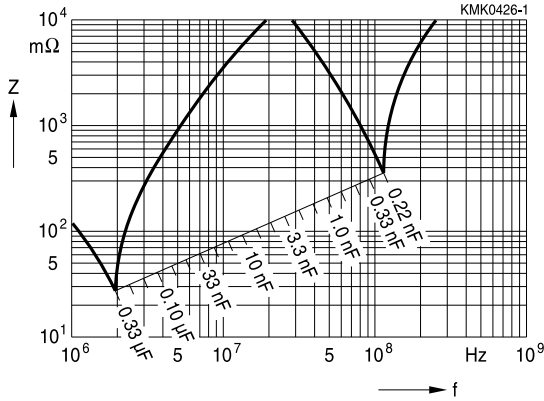

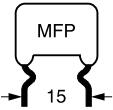

B32632

Very high pulse (wound)

**Permissible AC voltage  $V_{RMS}$  versus frequency  $f$  (for sinusoidal waveforms,  $T_A \leq 90^\circ C$ )**

For  $T_A > 90^\circ C$ , please refer to "General technical information", section 3.2.3.

**Lead spacing 15 mm**

630 V DC/300 V AC

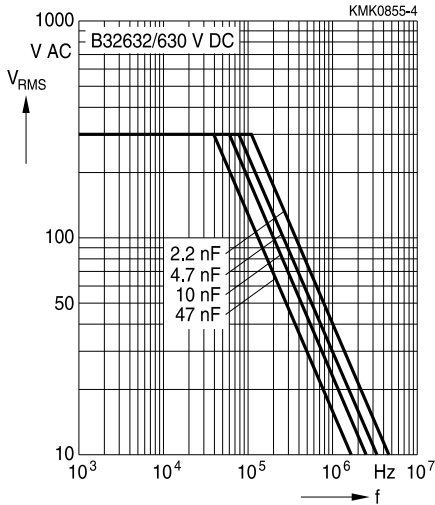

1250 V DC/450 V AC

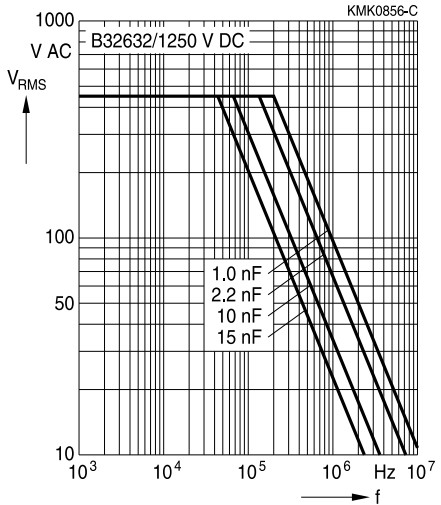

1600 V DC/450 V AC

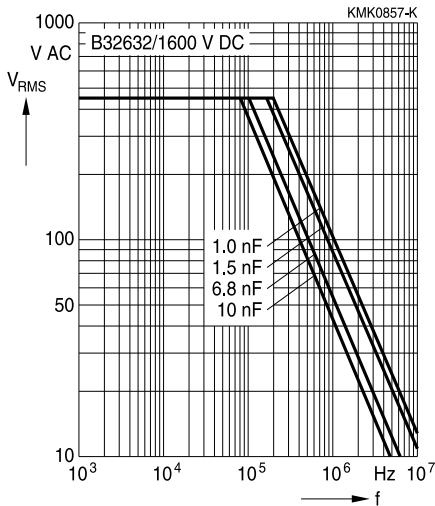

2000 V DC/500 V AC

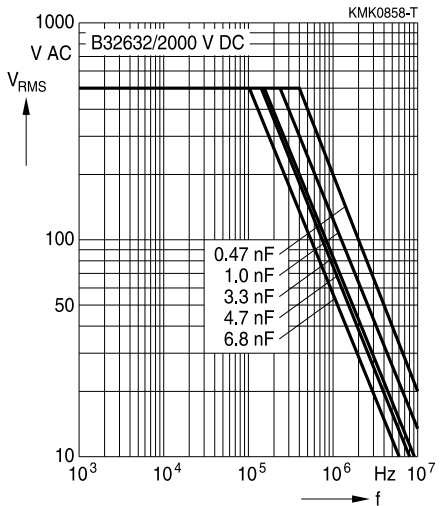

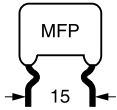

**Permissible AC voltage  $V_{RMS}$  versus frequency  $f$  (for sinusoidal waveforms,  $T_A \leq 90^\circ C$ )**  
 For  $T_A > 90^\circ C$ , please refer to "General technical information", section 3.2.3.

**Lead spacing 15 mm**

**3000 V DC/750 V AC**

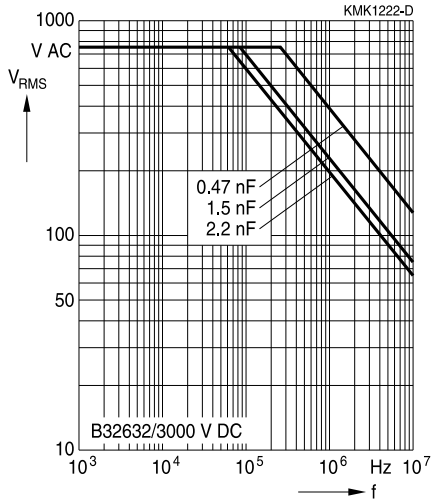

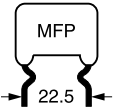

B32633

Very high pulse (wound)

Permissible AC voltage  $V_{RMS}$  versus frequency  $f$  (for sinusoidal waveforms,  $T_A \leq 90^\circ C$ )  
 For  $T_A > 90^\circ C$ , please refer to "General technical information", section 3.2.3.

Lead spacing 22.5 mm

630 V DC/300 V AC

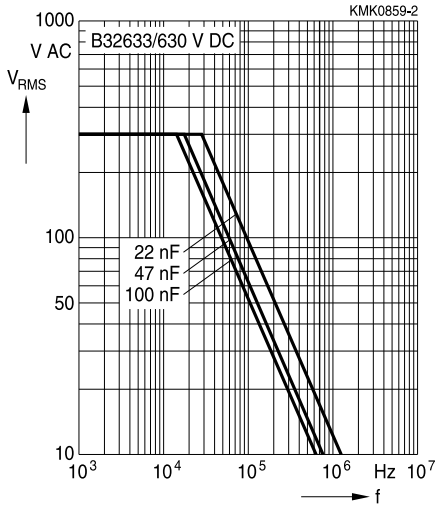

1250 V DC/450 V AC

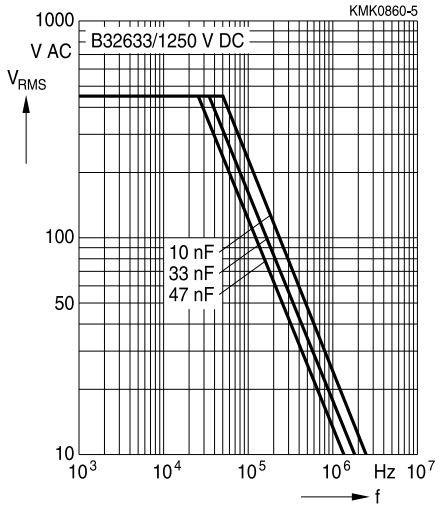

1600 V DC/450 V AC

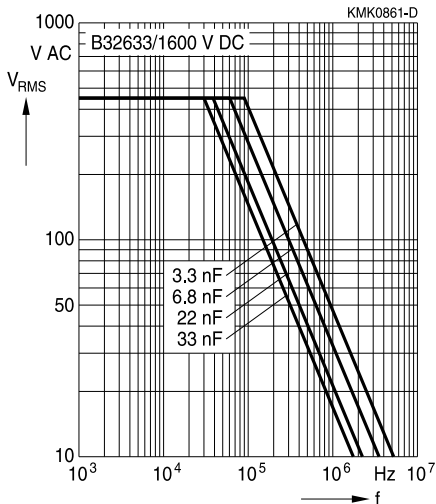

2000 V DC/500 V AC

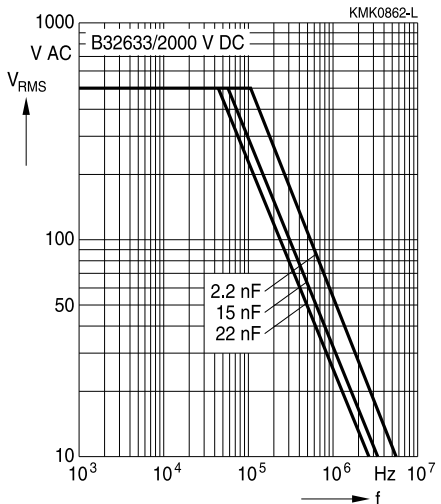

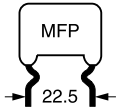

**Permissible AC voltage  $V_{RMS}$  versus frequency  $f$  (for sinusoidal waveforms,  $T_A \leq 90^\circ C$ )**  
 For  $T_A > 90^\circ C$ , please refer to "General technical information", section 3.2.3.

**Lead spacing 22.5 mm**

2500 V DC/750 V AC

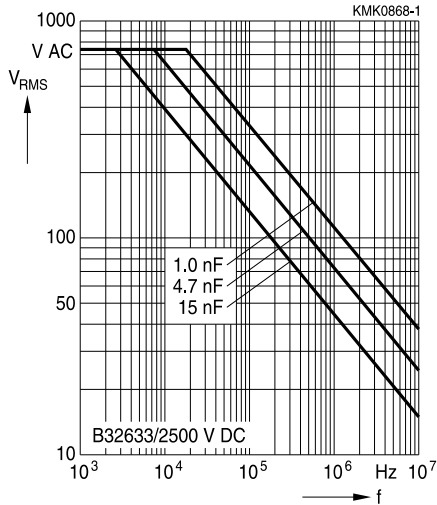

3000 V DC/750 V AC

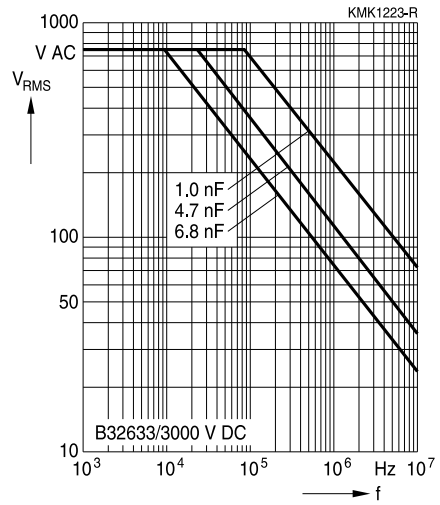

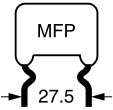

B32634

Very high pulse (wound)

Permissible AC voltage  $V_{RMS}$  versus frequency  $f$  (for sinusoidal waveforms,  $T_A \leq 90^\circ C$ )  
 For  $T_A > 90^\circ C$ , please refer to "General technical information", section 3.2.3.

Lead spacing 27.5 mm

630 V DC/300 V AC

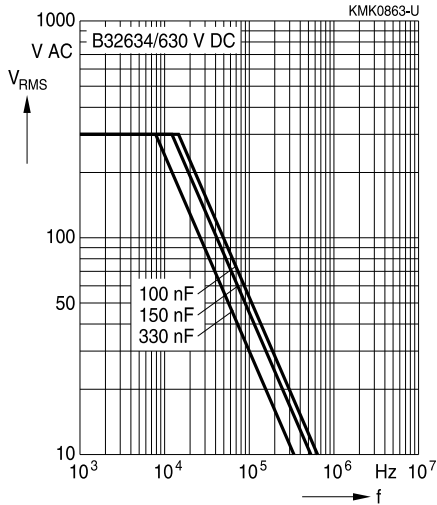

1250 V DC/450 V AC

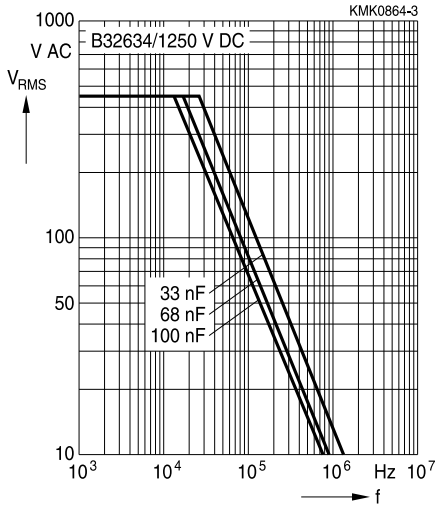

1600 V DC/450 V AC

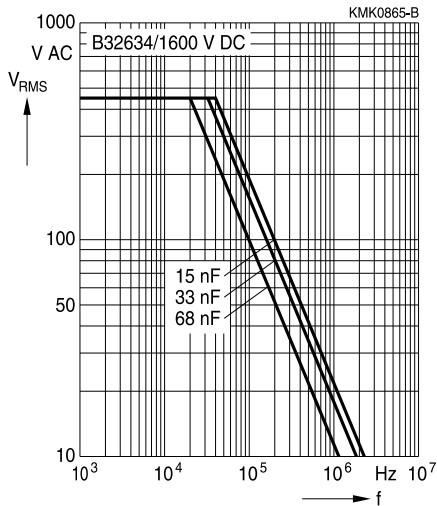

2000 V DC/500 V AC

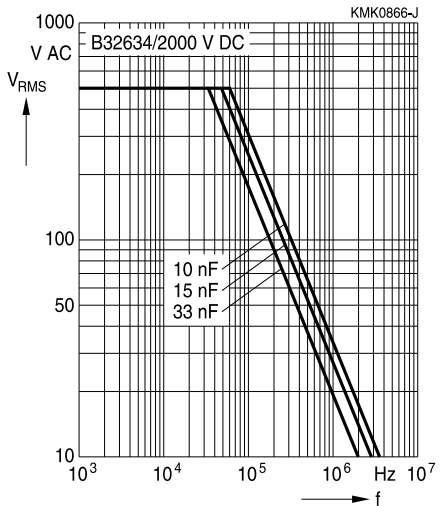



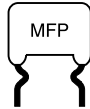

## Mounting guidelines

### 1 Soldering

#### 1.1 Solderability of leads

The solderability of terminal leads is tested to IEC 60068-2-20, test Ta, method 1.

Before a solderability test is carried out, terminals are subjected to accelerated ageing (to IEC 60068-2-2, test Ba: 4 h exposure to dry heat at 155 °C). Since the ageing temperature is far higher than the upper category temperature of the capacitors, the terminal wires should be cut off from the capacitor before the ageing procedure to prevent the solderability being impaired by the products of any capacitor decomposition that might occur.

Solder bath temperature	235 ±5 °C
Soldering time	2.0 ±0.5 s
Immersion depth	2.0 +0/-0.5 mm from capacitor body or seating plane
Evaluation criteria:	
Visual inspection	Wetting of wire surface by new solder ≥90%, free-flowing solder

#### 1.2 Resistance to soldering heat

Resistance to soldering heat is tested to IEC 60068-2-20, test Tb, method 1A.

Conditions:

Series	Solder bath temperature	Soldering time
MKT boxed (except 2.5 × 6.5 × 7.2 mm) coated uncoated (lead spacing > 10 mm)	260 ±5 °C	10 ±1 s
MFP MKP (lead spacing > 7.5 mm)		
MKT boxed (case 2.5 × 6.5 × 7.2 mm)		5 ±1 s
MKP (lead spacing ≤ 7.5 mm)		< 4 s
MKT uncoated (lead spacing ≤ 10 mm) insulated (B32559)		recommended soldering profile for MKT uncoated (lead spacing ≤ 10 mm) and insulated (B32559)

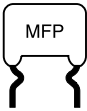

**B32632 ... B32634**

**Very high pulse (wound)**

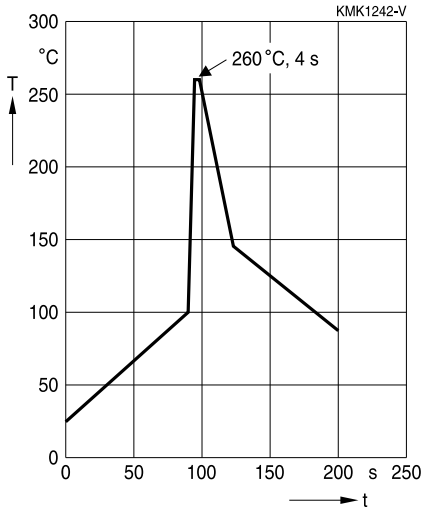

Immersion depth	2.0 +0/−0.5 mm from capacitor body or seating plane
Shield	Heat-absorbing board, (1.5 ±0.5) mm thick, between capacitor body and liquid solder
Evaluation criteria:	
Visual inspection	No visible damage
$\Delta C/C_0$	2% for MKT/MKP/MFP 5% for EMI suppression capacitors
$\tan \delta$	As specified in sectional specification



### 1.3 General notes on soldering

Permissible heat exposure loads on film capacitors are primarily characterized by the upper category temperature  $T_{max}$ . Long exposure to temperatures above this type-related temperature limit can lead to changes in the plastic dielectric and thus change irreversibly a capacitor's electrical characteristics. For short exposures (as in practical soldering processes) the heat load (and thus the possible effects on a capacitor) will also depend on other factors like:

- Pre-heating temperature and time
- Forced cooling immediately after soldering
- Terminal characteristics:
  - diameter, length, thermal resistance, special configurations (e.g. crimping)
- Height of capacitor above solder bath
- Shadowing by neighboring components
- Additional heating due to heat dissipation by neighboring components
- Use of solder-resist coatings

The overheating associated with some of these factors can usually be reduced by suitable countermeasures. For example, if a pre-heating step cannot be avoided, an additional or reinforced cooling process may possibly have to be included.

EPCOS recommends the following conditions:

- Pre-heating with a maximum temperature of 110 °C
- Temperature inside the capacitor should not exceed the following limits:
  - MKP/MFP 110 °C
  - MKT 160 °C
- When SMD components are used together with leaded ones, the leaded film capacitors should not pass into the SMD adhesive curing oven. The leaded components should be assembled after the SMD curing step.
- Leaded film capacitors are not suitable for reflow soldering.

#### Uncoated capacitors

For uncoated MKT capacitors with lead spacings  $\leq 10$  mm (B32560/B32561) the following measures are recommended:

- pre-heating to not more than 110 °C in the preheater phase
- rapid cooling after soldering



**B32632 ... B32634**

**Very high pulse (wound)**

### Cautions and warnings

- Do not exceed the upper category temperature (UCT).
- Do not apply any mechanical stress to the capacitor terminals.
- Avoid any compressive, tensile or flexural stress.
- Do not move the capacitor after it has been soldered to the PC board.
- Do not pick up the PC board by the soldered capacitor.
- Do not place the capacitor on a PC board whose PTH hole spacing differs from the specified lead spacing.
- Do not exceed the specified time or temperature limits during soldering.
- Avoid external energy inputs, such as fire or electricity.
- Avoid overload of the capacitors.

The table below summarizes the safety instructions that must always be observed. A detailed description can be found in the relevant sections of the chapters "General technical information" and "Mounting guidelines".

Topic	Safety information	Reference chapter "General technical information"
Storage conditions	Make sure that capacitors are stored within the specified range of time, temperature and humidity conditions.	4.5 "Storage conditions"
Flammability	Avoid external energy, such as fire or electricity (passive flammability), avoid overload of the capacitors (active flammability) and consider the flammability of materials.	5.3 "Flammability"
Resistance to vibration	Do not exceed the tested ability to withstand vibration. The capacitors are tested to IEC 60068-2-6. EPCOS offers film capacitors specially designed for operation under more severe vibration regimes such as those found in automotive applications. Consult our catalog "Film Capacitors for Automotive Electronics".	5.2 "Resistance to vibration"

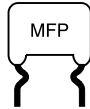

Topic	Safety information	Reference chapter "Mounting guidelines"
Soldering	Do not exceed the specified time or temperature limits during soldering.	1 "Soldering"
Cleaning	Use only suitable solvents for cleaning capacitors.	2 "Cleaning"
Embedding of capacitors in finished assemblies	When embedding finished circuit assemblies in plastic resins, chemical and thermal influences must be taken into account. Caution: Consult us first, if you also wish to embed other uncoated component types!	3 "Embedding of capacitors in finished assemblies"

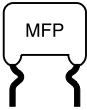

B32632 ... B32634

Very high pulse (wound)

## Symbols and terms

Symbol	English	German
$\alpha$	Heat transfer coefficient	Wärmeübergangszahl
$\alpha_C$	Temperature coefficient of capacitance	Temperaturkoeffizient der Kapazität
A	Capacitor surface area	Kondensatoroberfläche
$\beta_C$	Humidity coefficient of capacitance	Feuchtekoeffizient der Kapazität
C	Capacitance	Kapazität
$C_R$	Rated capacitance	Nennkapazität
$\Delta C$	Absolute capacitance change	Absolute Kapazitätsänderung
$\Delta C/C$	Relative capacitance change (relative deviation of actual value)	Relative Kapazitätsänderung (relative Abweichung vom Ist-Wert)
$\Delta C/C_R$	Capacitance tolerance (relative deviation from rated capacitance)	Kapazitätstoleranz (relative Abweichung vom Nennwert)
dt	Time differential	Differentielle Zeit
$\Delta t$	Time interval	Zeitintervall
$\Delta T$	Absolute temperature change (self-heating)	Absolute Temperaturänderung (Selbsterwärmung)
$\Delta \tan \delta$	Absolute change of dissipation factor	Absolute Änderung des Verlustfaktors
$\Delta V$	Absolute voltage change	Absolute Spannungsänderung
dV/dt	Time differential of voltage function (rate of voltage rise)	Differentielle Spannungsänderung (Spannungsflankensteilheit)
$\Delta V/\Delta t$	Voltage change per time interval	Spannungsänderung pro Zeitintervall
E	Activation energy for diffusion	Aktivierungsenergie zur Diffusion
ESL	Self-inductance	Eigeninduktivität
ESR	Equivalent series resistance	Ersatz-Serienwiderstand
f	Frequency	Frequenz
$f_1$	Frequency limit for reducing permissible AC voltage due to thermal limits	Grenzfrequenz für thermisch bedingte Reduzierung der zulässigen Wechselspannung
$f_2$	Frequency limit for reducing permissible AC voltage due to current limit	Grenzfrequenz für strombedingte Reduzierung der zulässigen Wechselspannung
$f_r$	Resonant frequency	Resonanzfrequenz
$F_D$	Thermal acceleration factor for diffusion	Therm. Beschleunigungsfaktor zur Diffusion
$F_T$	Derating factor	Deratingfaktor
i	Current (peak)	Stromspitze
$I_C$	Category current (max. continuous current)	Kategoriestrom (max. Dauerstrom)

Symbol	English	German
$I_{RMS}$	(Sinusoidal) alternating current, root-mean-square value	(Sinusförmiger) Wechselstrom
$i_z$	Capacitance drift	Inkonstanz der Kapazität
$k_0$	Pulse characteristic	Impuls Kennwert
$L_S$	Series inductance	Serieninduktivität
$\lambda$	Failure rate	Ausfallrate
$\lambda_0$	Constant failure rate during useful service life	Konstante Ausfallrate in der Nutzungsphase
$\lambda_{test}$	Failure rate, determined by tests	Experimentell ermittelte Ausfallrate
$P_{diss}$	Dissipated power	Abgegebene Verlustleistung
$P_{gen}$	Generated power	Erzeugte Verlustleistung
$Q$	Heat energy	Wärmeenergie
$\rho$	Density of water vapor in air	Dichte von Wasserdampf in Luft
$R$	Universal molar constant for gases	Allg. Molarkonstante für Gas
$R$	Ohmic resistance of discharge circuit	Ohmscher Widerstand des Entladekreises
$R_i$	Internal resistance	Innenwiderstand
$R_{ins}$	Insulation resistance	Isolationswiderstand
$R_P$	Parallel resistance	Parallelwiderstand
$R_S$	Series resistance	Serienwiderstand
$S$	severity (humidity test)	Schärfegrad (Feuchtest)
$t$	Time	Zeit
$T$	Temperature	Temperatur
$\tau$	Time constant	Zeitkonstante
$\tan \delta$	Dissipation factor	Verlustfaktor
$\tan \delta_D$	Dielectric component of dissipation factor	Dielektrischer Anteil des Verlustfaktors
$\tan \delta_P$	Parallel component of dissipation factor	Parallelanteil des Verlustfaktors
$\tan \delta_S$	Series component of dissipation factor	Serienanteil des Verlustfaktors
$T_A$	Ambient temperature	Umgebungstemperatur
$T_{max}$	Upper category temperature	Obere Kategorietemperatur
$T_{min}$	Lower category temperature	Untere Kategorietemperatur
$t_{OL}$	Operating life at operating temperature and voltage	Betriebszeit bei Betriebstemperatur und -spannung
$T_{op}$	Operating temperature	Betriebstemperatur
$T_R$	Rated temperature	Nenntemperatur
$T_{ref}$	Reference temperature	Referenztemperatur
$t_{SL}$	Reference service life	Referenz-Lebensdauer
$V_{AC}$	AC voltage	Wechselspannung

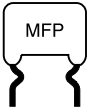

**B32632 ... B32634**

**Very high pulse (wound)**

Symbol	English	German
$V_C$	Category voltage	Kategoriespannung
$V_{C,RMS}$	Category AC voltage	(Sinusförmige) Kategorie-Wechselspannung
$V_{CD}$	Corona-discharge onset voltage	Teilentlade-Einsatzspannung
$V_{ch}$	Charging voltage	Ladespannung
$V_{DC}$	DC voltage	Gleichspannung
$V_{FB}$	Fly-back capacitor voltage	Spannung (Flyback)
$V_i$	Input voltage	Eingangsspannung
$V_o$	Output voltage	Ausgangssspannung
$V_{op}$	Operating voltage	Betriebsspannung
$V_p$	Peak pulse voltage	Impuls-Spitzenspannung
$V_{pp}$	Peak-to-peak voltage Impedance	Spannungshub
$V_R$	Rated voltage	Nennspannung
$\hat{V}_R$	Amplitude of rated AC voltage	Amplitude der Nenn-Wechselspannung
$V_{RMS}$	(Sinusoidal) alternating voltage, root-mean-square value	(Sinusförmige) Wechselspannung
$V_{SC}$	S-correction voltage	Spannung bei Anwendung "S-correction"
$V_{sn}$	Snubber capacitor voltage	Spannung bei Anwendung "Beschaltung"
$Z$	Impedance	Scheinwiderstand
$e$	Lead spacing	Rastermaß



## Important notes

The following applies to all products named in this publication:

1. Some parts of this publication contain **statements about the suitability of our products for certain areas of application**. These statements are based on our knowledge of typical requirements that are often placed on our products in the areas of application concerned. We nevertheless expressly point out **that such statements cannot be regarded as binding statements about the suitability of our products for a particular customer application**. As a rule we are either unfamiliar with individual customer applications or less familiar with them than the customers themselves. For these reasons, it is always ultimately incumbent on the customer to check and decide whether a product with the properties described in the product specification is suitable for use in a particular customer application.
2. We also point out that **in individual cases, a malfunction of electronic components or failure before the end of their usual service life cannot be completely ruled out in the current state of the art, even if they are operated as specified**. In customer applications requiring a very high level of operational safety and especially in customer applications in which the malfunction or failure of an electronic component could endanger human life or health (e.g. in accident prevention or life-saving systems), it must therefore be ensured by means of suitable design of the customer application or other action taken by the customer (e.g. installation of protective circuitry or redundancy) that no injury or damage is sustained by third parties in the event of malfunction or failure of an electronic component.
3. **The warnings, cautions and product-specific notes must be observed.**
4. In order to satisfy certain technical requirements, **some of the products described in this publication may contain substances subject to restrictions in certain jurisdictions (e.g. because they are classed as hazardous)**. Useful information on this will be found in our Material Data Sheets on the Internet ([www.tdk-electronics.tdk.com/material](http://www.tdk-electronics.tdk.com/material)). Should you have any more detailed questions, please contact our sales offices.
5. We constantly strive to improve our products. Consequently, **the products described in this publication may change from time to time**. The same is true of the corresponding product specifications. Please check therefore to what extent product descriptions and specifications contained in this publication are still applicable before or when you place an order.  
  
We also **reserve the right to discontinue production and delivery of products**. Consequently, we cannot guarantee that all products named in this publication will always be available. The aforementioned does not apply in the case of individual agreements deviating from the foregoing for customer-specific products.
6. Unless otherwise agreed in individual contracts, **all orders are subject to our General Terms and Conditions of Supply**.
7. **Our manufacturing sites serving the automotive business apply the IATF 16949 standard**. The IATF certifications confirm our compliance with requirements regarding the quality management system in the automotive industry. Referring to customer requirements and customer specific requirements ("CSR") TDK always has and will continue to have the policy of respecting individual agreements. Even if IATF 16949 may appear to support the acceptance of unilateral requirements, we hereby like to emphasize that **only requirements mutually agreed upon can and will be implemented in our Quality Management System**. For clarification purposes we like to point out that obligations from IATF 16949 shall only become legally binding if individually agreed upon.
8. The trade names EPCOS, CeraCharge, CeraDiode, CeraLink, CeraPad, CeraPlas, CSMP, CTVS, DeltaCap, DigiSiMic, ExoCore, FilterCap, FormFit, LeaXield, MiniBlue, MiniCell, MKD, MKK, MotorCap, PCC, PhaseCap, PhaseCube, PhaseMod, PhiCap, PowerHap, PQSine, PQvar, SIFERRIT, SIFI, SIKOREL, SilverCap, SIMDAD, SiMic, SIMID, SineFormer, SIOV, ThermoFuse, WindCap are **trademarks registered or pending** in Europe and in other countries. Further information will be found on the Internet at [www.tdk-electronics.tdk.com/trademarks](http://www.tdk-electronics.tdk.com/trademarks).